

Type Coffee Vending Machine	Model 9100 - IN	N° T.I. 03 - 2018	
Serial Number 74813349	Subject Modification of the BOILER THERMAL PROTECTION Wiring	ISSUED FOR (X)	Action Information X

REASON:

Be informed that, starting from S/N **74813349**, the *boiler thermal protection wiring* has been modified as shown below.

MODIFICATIONS: the modification is **mandatory** also for the machines previous to S/N above.

New
boiler thermal protection wiring

Pre-modification
boiler thermal protection wiring

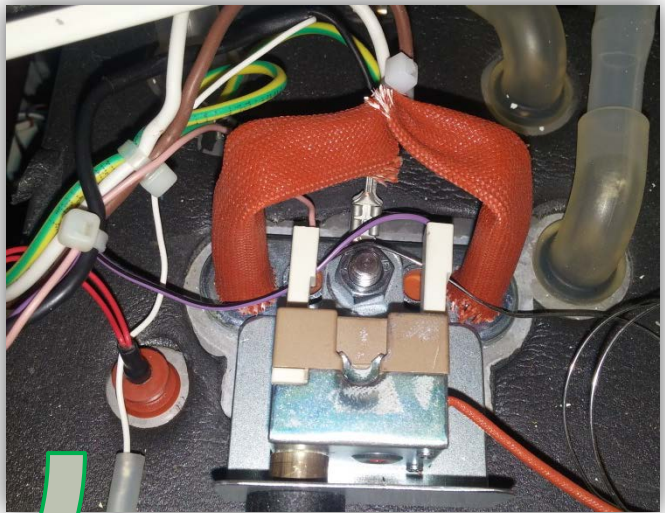
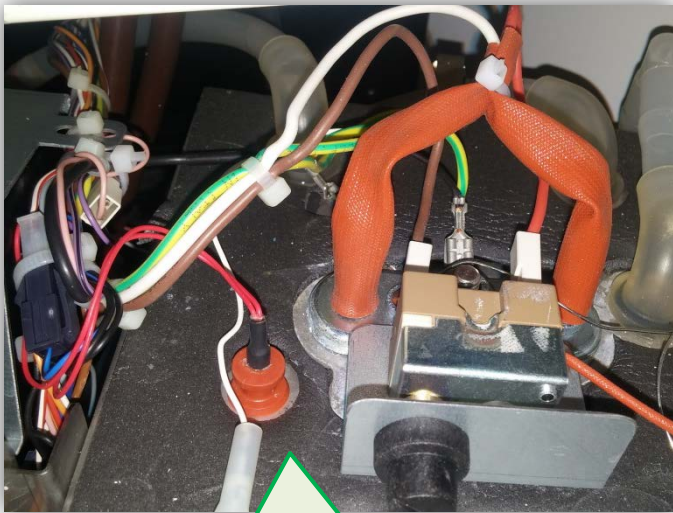

It's available a **retrofit KIT** to modify a machine previous to S/N above to the **new solution**.
The **KIT (1, 2, 3, 4)** spare code is: **F00401**

1

N. 1 pc



2

Female faston cover - N. 2 pcs



3

Double male terminal - N. 1 pc



4

Cable tie - N. 3 pcs

Type Coffee Vending Machine	Model 9100 - IN	N° T.I. 03 - 2018
Serial Number 74813349	Subject Modification of the BOILER THERMAL PROTECTION Wiring	ISSUED FOR (X) Action Information X

Detail of the new wiring diagram

Detail of the pre-modification wiring diagram

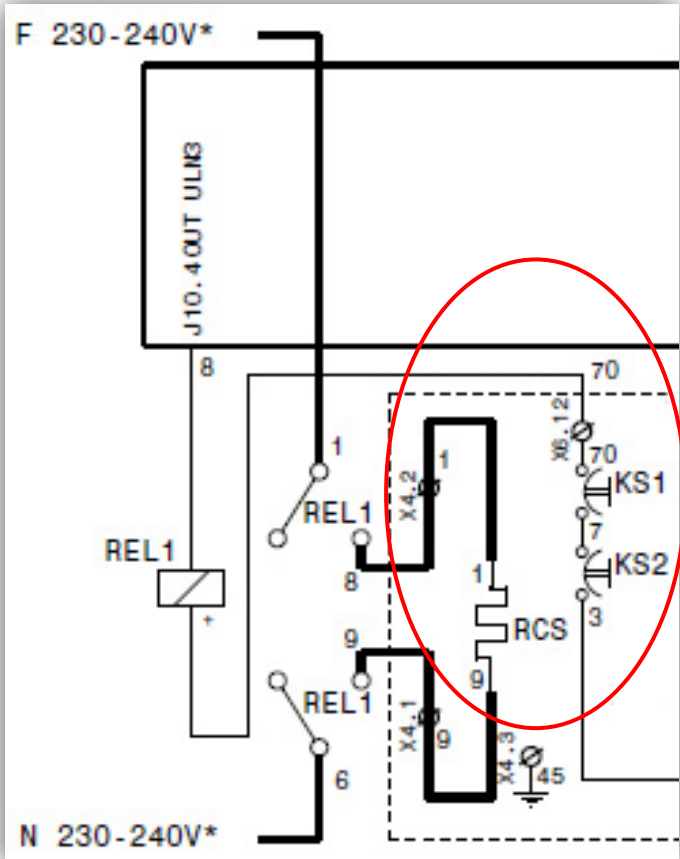
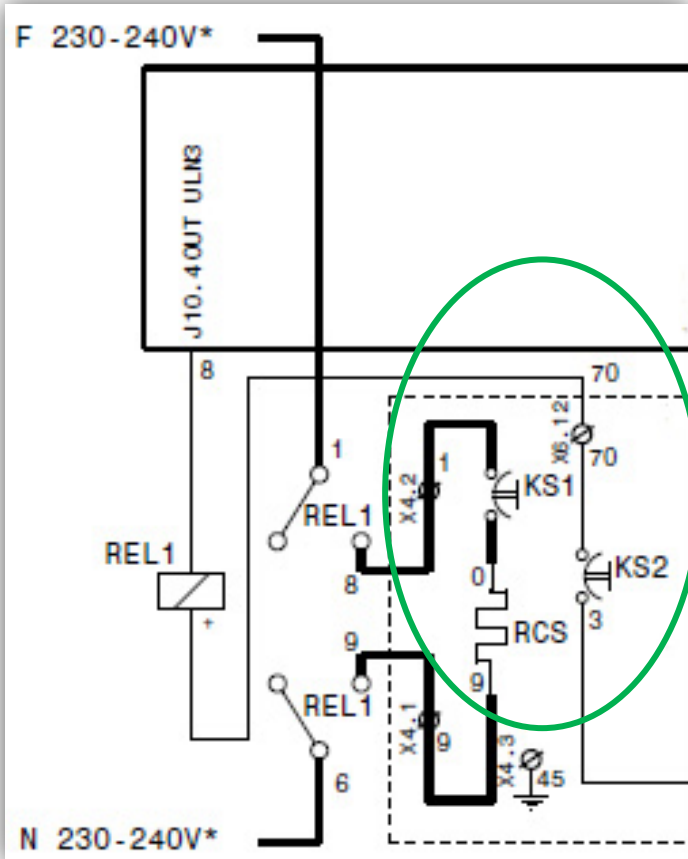

New dry boil thermal cut – out connection

Actual dry boil thermal cut – out connection

Colour legend of the wiring

0	BLACK
1	BROWN
2	RED
3	ORANGE
4	YELLOW
5	GREEN
6	BLUE
7	LIGHT BLUE
8	PINK
9	VIOLET
	GREY
	WHITE

Type Coffee Vending Machine	Model 9100 - IN	N° T.I. 03 - 2018
Serial Number 74813349	Subject Modification of the BOILER THERMAL PROTECTION Wiring	ISSUED FOR (X) Action Information X

➤ Follow the steps below to **retrofit** the machine to the **new** solution.

1. Open the door

2. Switch – off the machine

3. Unplug the machine from the mains



4. Remove the boiler cover

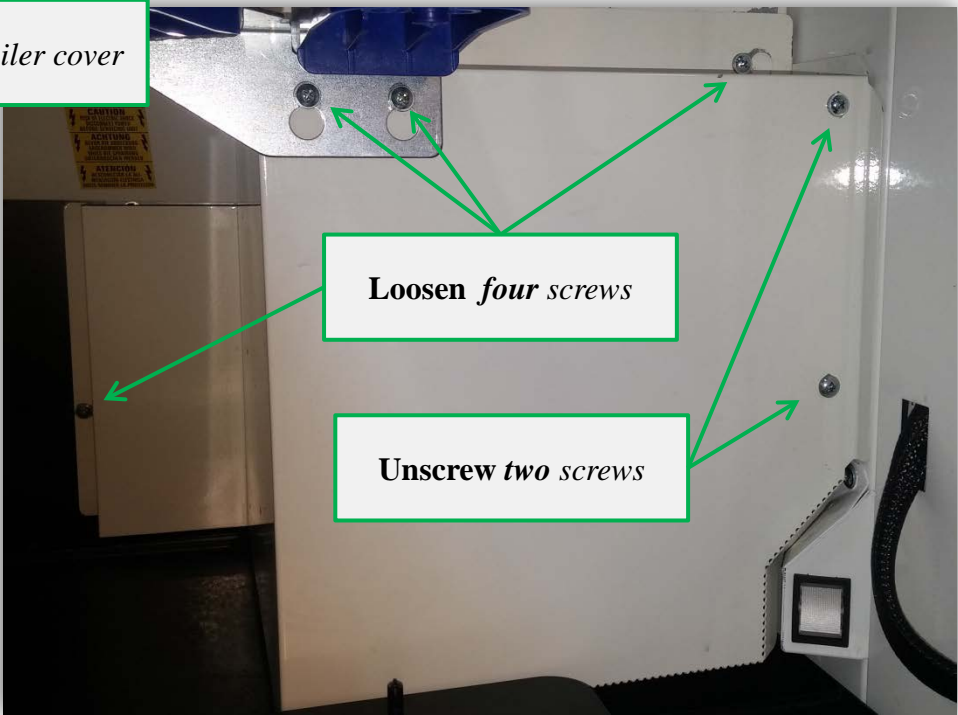

Type Coffee Vending Machine	Model 9100 - IN	N° T.I. 03 - 2018				
Serial Number 74813349	Subject Modification of the BOILER THERMAL PROTECTION Wiring	ISSUED FOR (X) <table border="1"> <tr> <td>Action</td> <td></td> </tr> <tr> <td>Information</td> <td>X</td> </tr> </table>	Action		Information	X
Action						
Information	X					

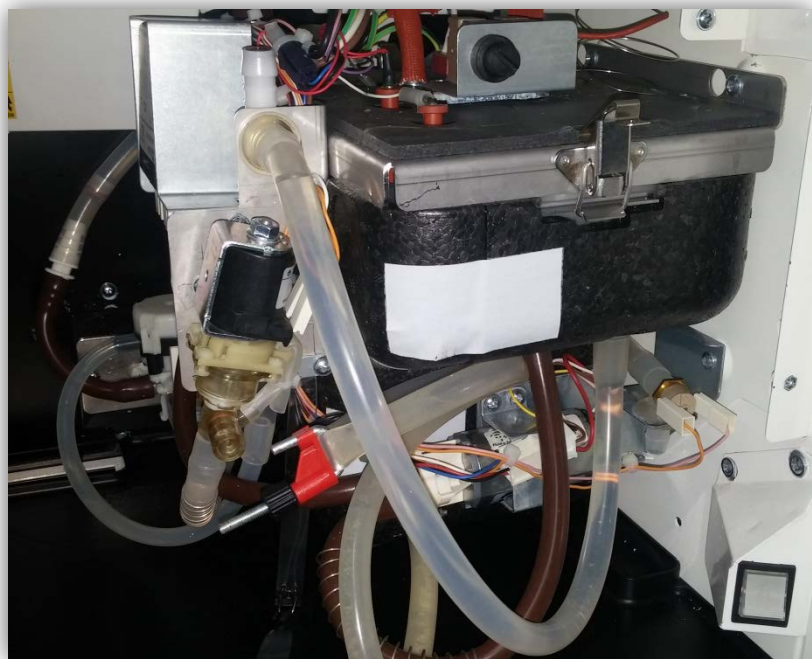

Boiler *without cover*

5. Loosen *two screws* of the boiler support

6. Pull *the boiler out* just enough to operate on the boiler top

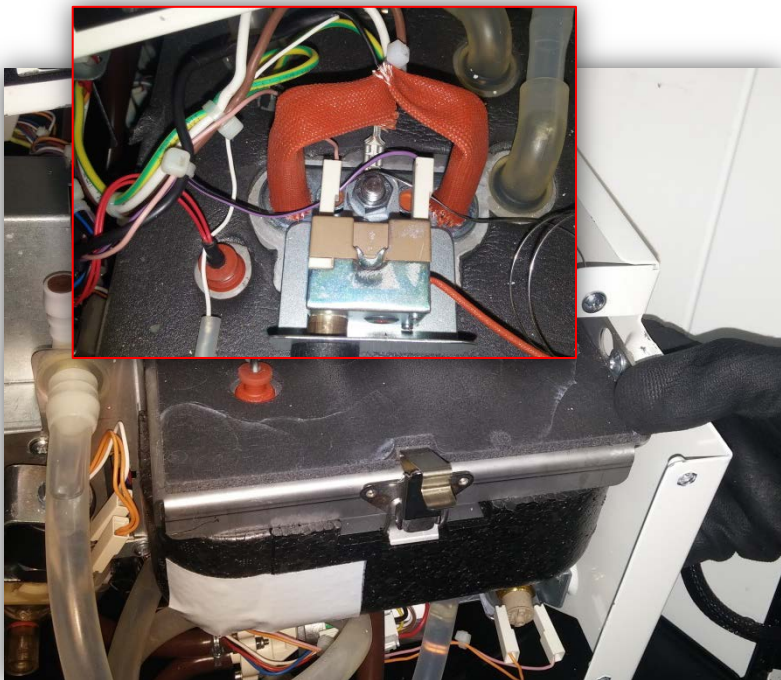

Type Coffee Vending Machine	Model 9100 - IN	N° T.I. 03 - 2018
Serial Number 74813349	Subject Modification of the BOILER THERMAL PROTECTION Wiring	ISSUED FOR (X) Action Information X

Pre-modification
Top View of the boiler

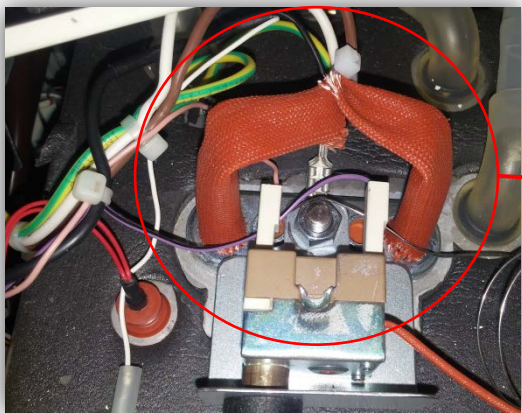

7. Unplug the two faston of the thermal cut - out

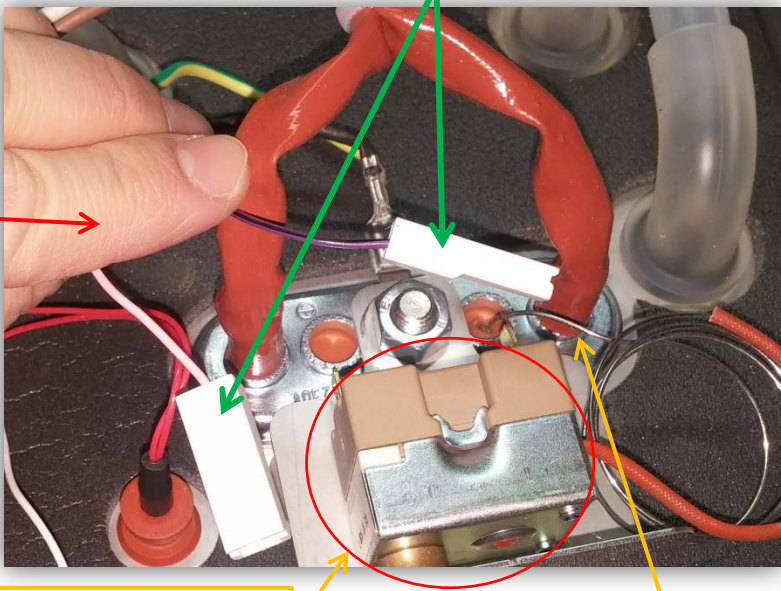

Thermal cut - out

Heating element

8. Plug the two faston to the double male terminal

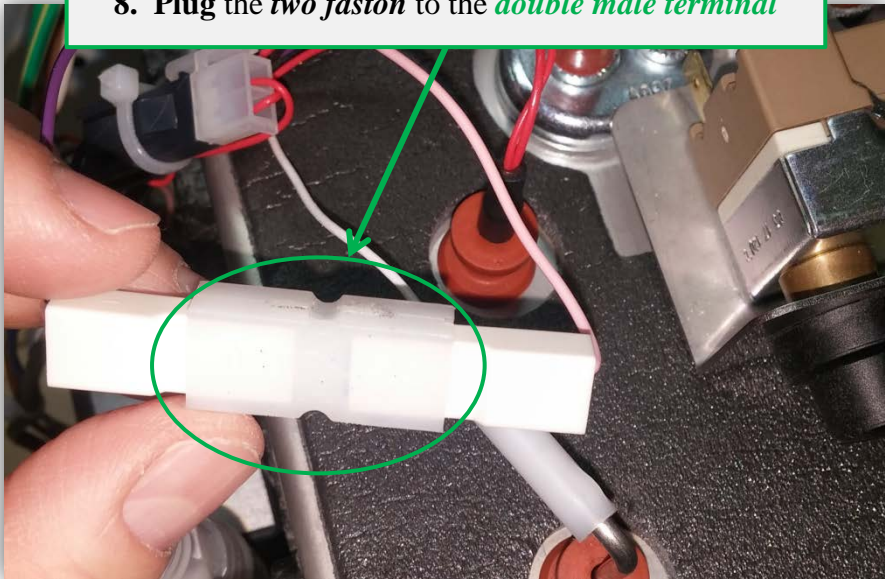

Type Coffee Vending Machine	Model 9100 - IN	N° T.I. 03 - 2018
Serial Number 74813349	Subject Modification of the BOILER THERMAL PROTECTION Wiring	ISSUED FOR (X) Action Information X

9. Fix the assembly *fastons* + *double male terminal* to the wiring by means of a *cable - tie*

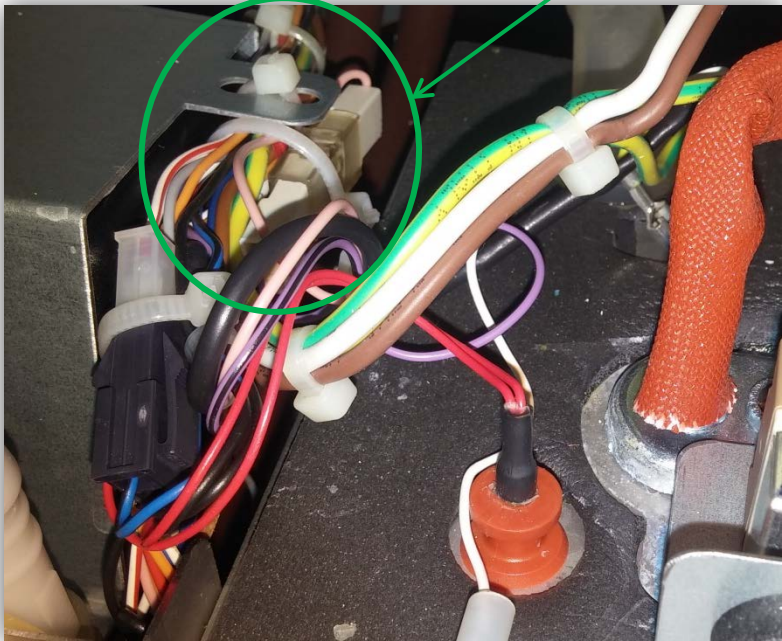

10. Cut and remove the *cable - tie*

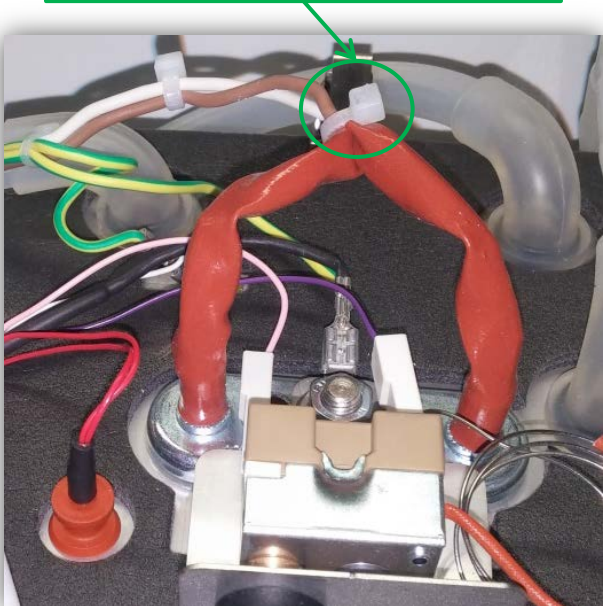

11. Remove the *cable covering* and unplug the *female faston*

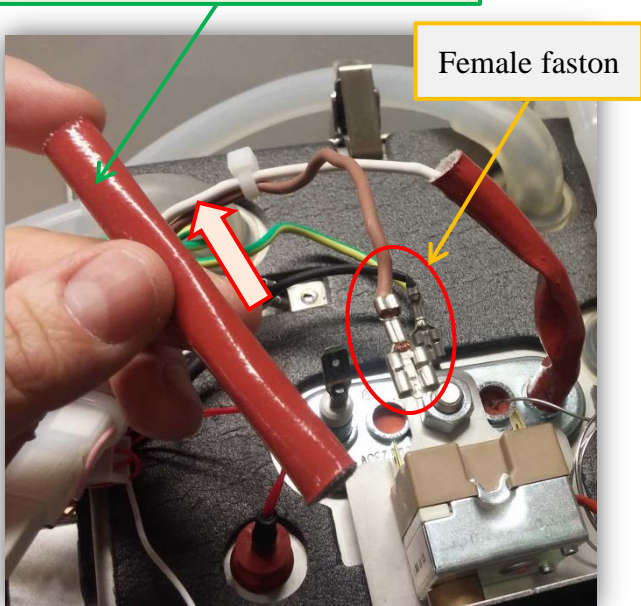

Type Coffee Vending Machine	Model 9100 - IN	N° T.I. 03 - 2018
Serial Number 74813349	Subject Modification of the BOILER THERMAL PROTECTION Wiring	ISSUED FOR (X) Action Information X

12. Put the cover on the female faston



13. Plug - in the female faston



14. Unplug the second female faston



15. Plug - in the female faston to the heating element and put the cable covering back

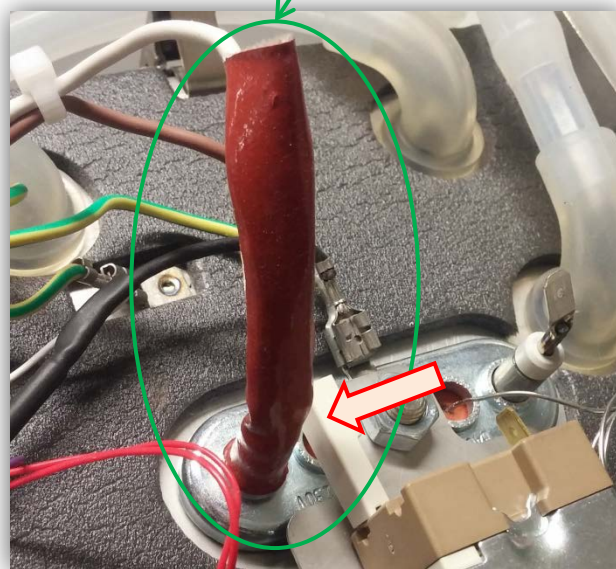

Type Coffee Vending Machine	Model 9100 - IN	N° T.I. 03 - 2018
Serial Number 74813349	Subject Modification of the BOILER THERMAL PROTECTION Wiring	ISSUED FOR (X) Action Information X

16. Take the *wiring* of the retrofit **KIT**



17. Take the *cable covering* (removed at step 11) and put it on the wiring



18. Plug - in the *wiring* as shown below: from the *thermal cut - out* to the *heating element*

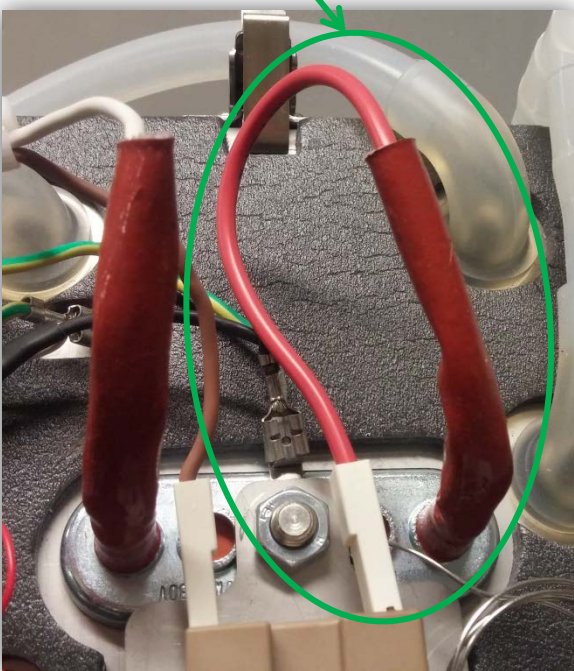

19. Fix the *two wiring* by means of a *cable - tie*

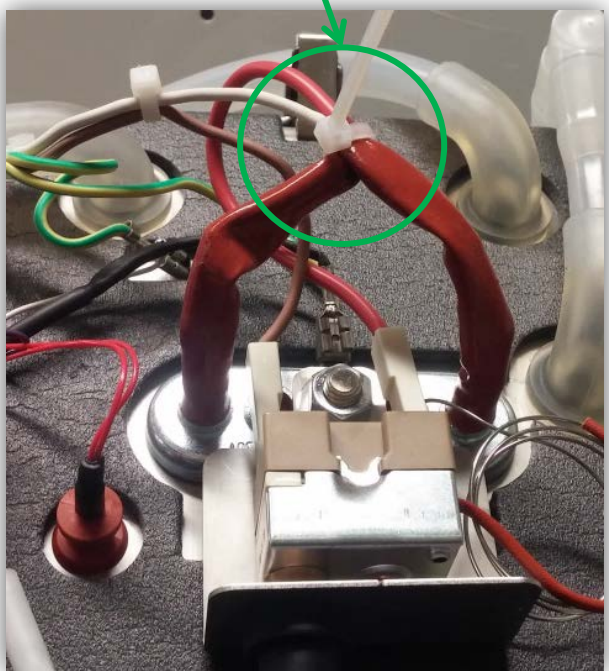

Type Coffee Vending Machine	Model 9100 - IN	N° T.I. 03 - 2018					
Serial Number 74813349	Subject Modification of the BOILER THERMAL PROTECTION Wiring	ISSUED FOR (X)	<table border="1"> <tr> <td>Action</td> <td></td> </tr> <tr> <td>Information</td> <td>X</td> </tr> </table>	Action		Information	X
Action							
Information	X						

20. Move backward the steps **6, 5, 4, 3, 2, 1**

21. Finally in order to complete the modification, dispense some drinks to verify that anything has been done properly.